

Performance Curve

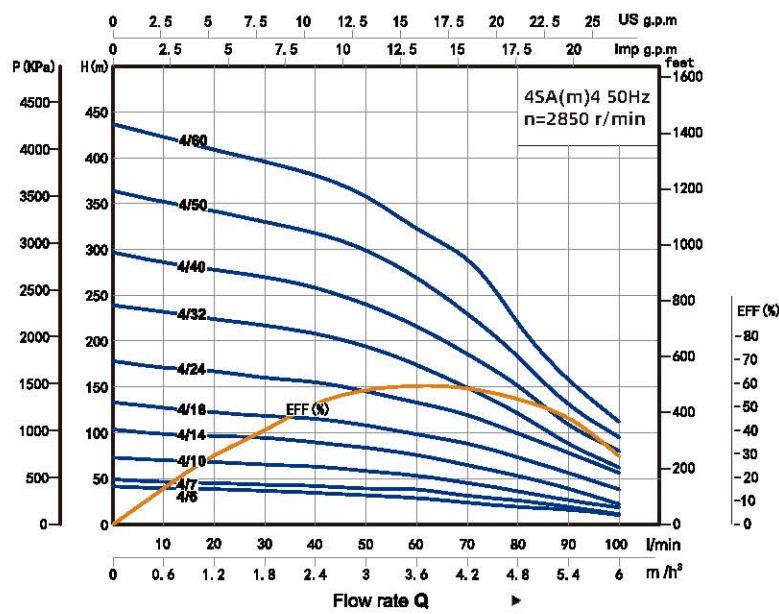

Performance Curve

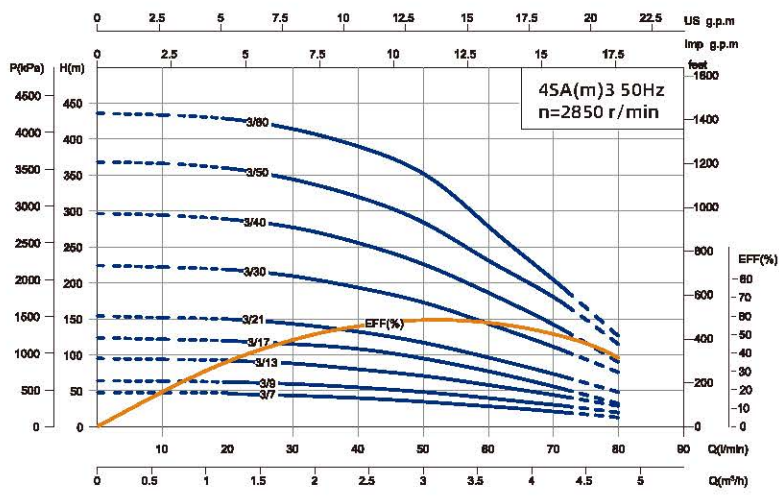
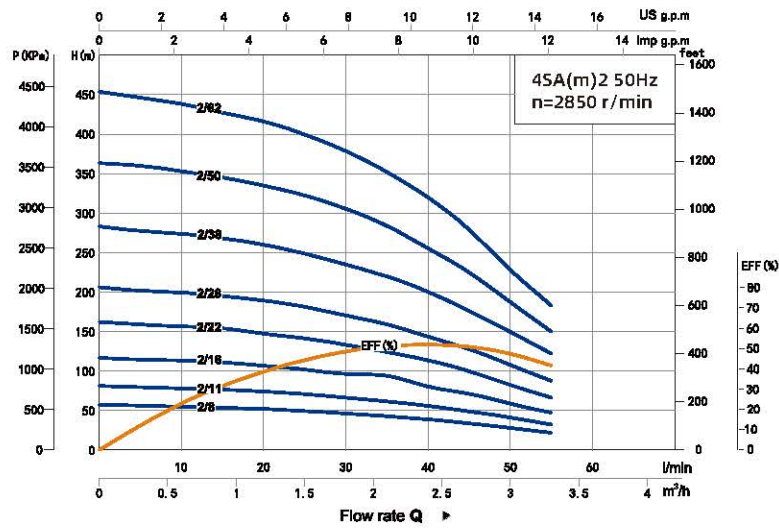
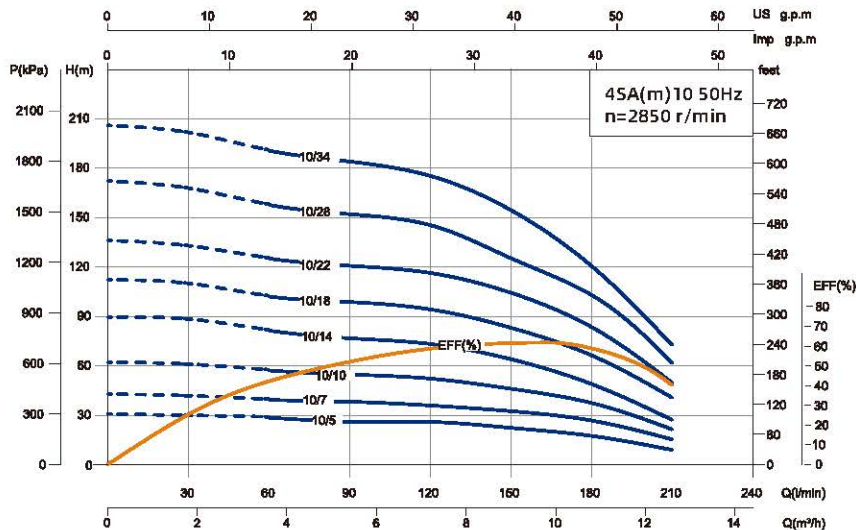
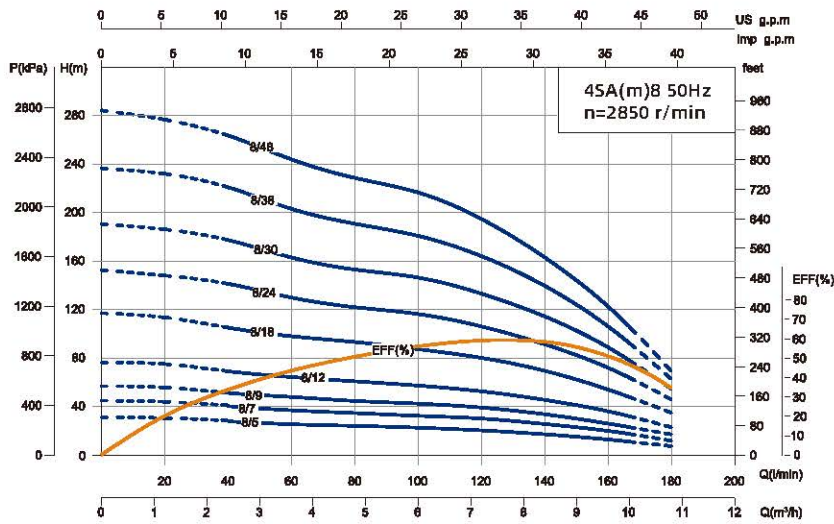
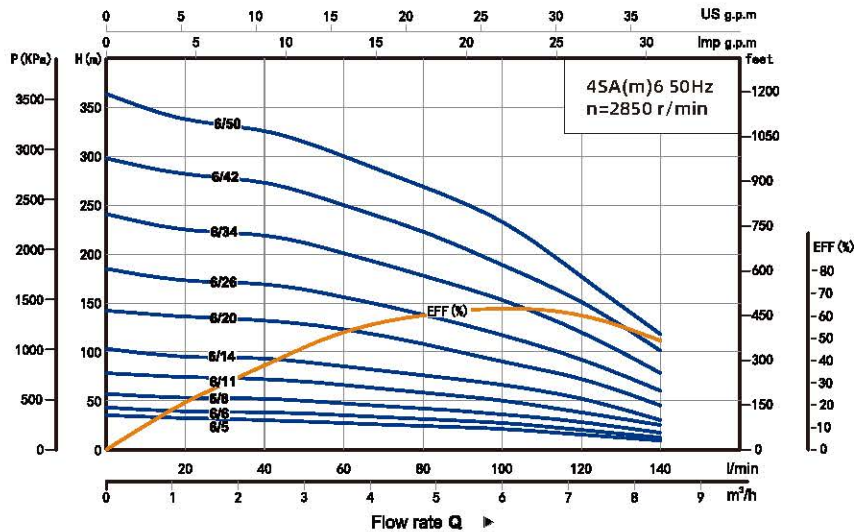

Performance Curve

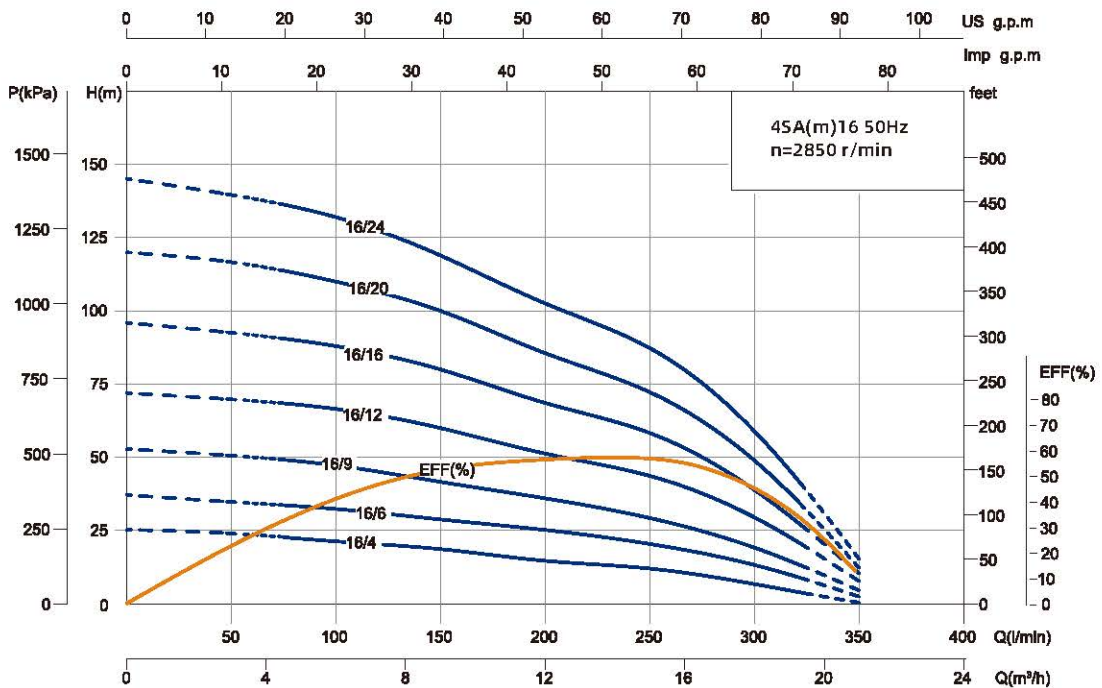
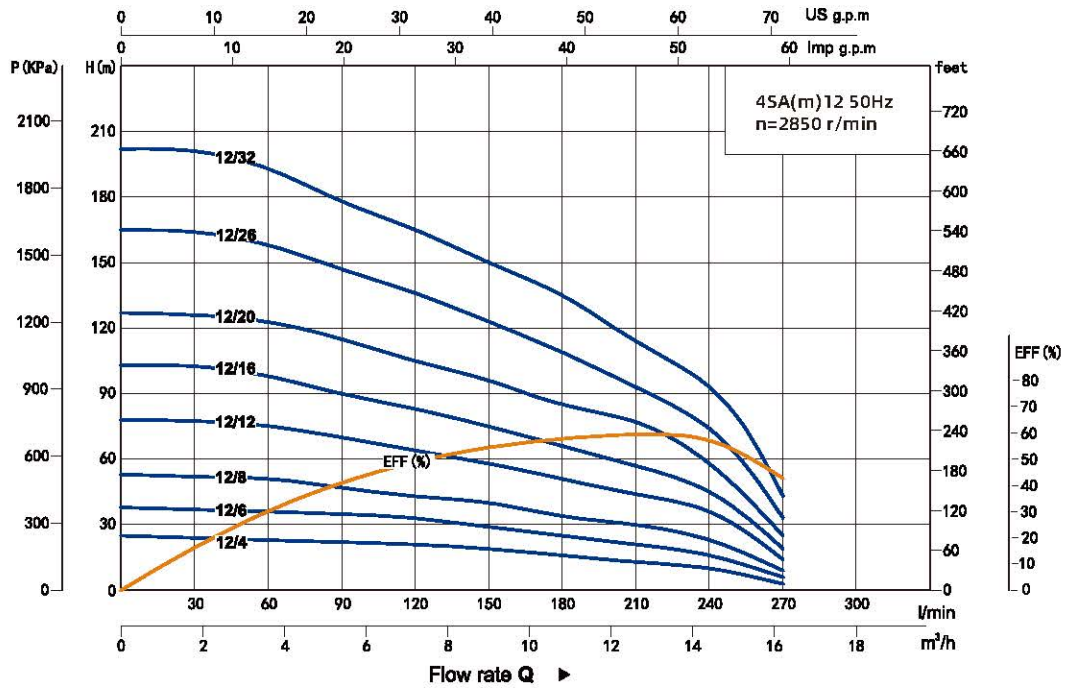

Model		Power		Rate Current (A)		Flow													Head Range (m)	
Single-Phase	Three-Phase	kW	HP	Single-Phase	Three-Phase	m ³ /h	0	0.3	0.6	0.9	1.2	1.5	1.8	2.1	2.4	2.7	3	3.3		3.6
220V	380V			220V	380V	l/min	0	5	10	15	20	25	30	35	40	45	50	55		60
4SAm2/8	-	0.37	0.5	4.2	-	H(m)	58	56	55	54	52	50	46	43	38	34	27	21	15	55~22
4SAm2/11	-	0.55	0.75	5.2	-		80	80	79	77	74	71	67	62	56	49	41	32	23	77~34
4SAm2/16	4SA2/16	0.75	1	6.9	2.7		117	114	113	111	106	102	96	94	80	71	58	47	35	113~49
4SAm2/22	4SA2/22	1.1	1.5	9.5	3.6		162	159	156	154	147	141	133	124	113	100	82	66	50	156~69
4SAm2/28	4SA2/28	1.5	2	12.2	4.8		206	202	199	195	189	181	170	159	143	128	108	87	62	199~91
4SAm2/38	4SA2/38	2.2	3	17.3	6.4		283	278	274	268	260	249	235	220	200	176	150	122	91	274~127
4SAm2/50	4SA2/50	3	4	21	10.5		364	360	353	345	335	323	306	284	256	225	188	150	109	353~156
4SAm2/62	4SA2/62	4	5.5	27	12.7		454	446	438	427	416	400	379	352	320	279	228	183	135	438~190

Model		Power		Rate Current (A)		Flow											Head Range (m)
Single-Phase	Three-Phase	kW	HP	Single-Phase	Three-Phase	m ³ /h	0	0.6	1.2	1.8	2.4	3	3.6	4.2	4.8		
220V	380V			220V	380V	l/min	0	10	20	30	40	50	60	70	80		
4SAm3/7	-	0.37	0.5	4.2	-	H(m)	49	48	47	44	40	35	28	23	12	47~25	
4SAm3/9	-	0.55	0.75	5.2	-		65	64	63	60	55	48	40	30	19	63~35	
4SAm3/13	4SA3/13	0.75	1	6.9	2.7		96	93	92	89	80	71	58	44	28	92~51	
4SAm3/17	4SA3/17	1.1	1.5	9.5	3.6		125	122	120	116	109	95	77	56	32	120~67	
4SAm3/21	4SA3/21	1.5	2	12.2	4.8		155	153	150	144	133	117	96	73	48	150~85	
4SAm3/30	4SA3/30	2.2	3	17.3	6.4		225	223	219	210	194	173	143	111	75	219~127	
4SAm3/40	4SA3/40	3	4	21	10.5		297	295	289	278	256	226	186	142	89	289~165	
4SAm3/50	4SA3/50	4	5.5	27	12.7		369	367	360	344	320	284	231	180	114	360~206	
-	4SA3/60	5.5	7.5	-	17.5	436	434	429	415	387	352	273	204	125	429~241		

Model		Power		Rate Current (A)		Flow													Head Range (m)
Single-Phase	Three-Phase	kW	HP	Single-Phase	Three-Phase	m ³ /h	0	0.6	1.2	1.8	2.4	3	3.6	4.2	4.8	5.4	6		
220V	380V			220V	380V	l/min	0	10	20	30	40	50	60	70	80	90	100		
4SAm4/6	-	0.37	0.5	4.2	-	H(m)	42	40	39	37	35	32	29	24	19	16	10	39~15	
4SAm4/7	-	0.55	0.75	5.2	-		50	46	45	43	42	39	38	31	26	19	11	45~19	
4SAm4/10	4SA4/10	0.75	1	6.9	2.7		74	71	69	66	64	59	54	46	37	27	19	69~30	
4SAm4/14	4SA4/14	1.1	1.5	9.5	3.6		104	99	97	95	90	84	76	65	53	39	22	97~43	
4SAm4/18	4SA4/18	1.5	2	12.2	4.8		133	127	122	118	115	108	98	88	73	56	38	124~57	
4SAm4/24	4SA4/24	2.2	3	17.3	6.4		178	171	167	160	155	145	133	119	99	78	56	167~79	
4SAm4/32	4SA4/32	3	4	21	10.5		239	232	224	217	208	194	174	149	121	88	62	210~100	
4SAm4/40	4SA4/40	4	5.5	27	12.7		297	286	278	270	258	240	216	186	151	109	80	266~110	
-	4SA4/50	5.5	7.5	-	17.5		364	352	342	330	318	299	269	230	183	131	95	336~177	
-	4SA4/60	7.5	10	-	19.6		437	423	409	396	381	358	323	289	220	158	112	404~210	

Model		Power		Rate Current (A)		Flow								Head Range (m)	
Single-Phase	Three-Phase	kW	HP	Single-Phase	Three-Phase	m ³ /h	0	1.2	2.4	3.6	4.8	6	7.2		8.4
220V	380V			220V	380V	l/min	0	20	40	60	80	100	120		140
4SAm6/5	-	0.37	0.55	4.2	-	H(m)	35	32	30	27	24	21	15	9	30~11
4SAm6/6	-	0.55	0.75	5.2	-		43	39	38	35	31	27	20	12	38~16
4SAm6/8	4SA6/8	0.75	1	6.9	2.7		57	53	52	47	42	36	28	17	52~22
4SAm6/11	4SA6/11	1.1	1.5	9.5	3.6		78	74	72	66	58	50	38	25	73~31
4SAm6/14	4SA6/14	1.5	2	12.2	4.8		103	95	93	85	76	66	52	30	93~40
4SAm6/20	4SA6/20	2.2	3	17.3	6.4		142	136	132	123	108	90	72	45	135~55
4SAm6/26	4SA6/26	3	4	21	10.5		185	173	169	156	138	117	92	60	172~75
4SAm6/34	4SA6/34	4	5.5	27	12.7		241	225	219	201	178	153	120	78	223~98
-	4SA6/42	5.5	7.5	-	17.5		298	282	273	250	223	189	151	101	278~130
-	4SA6/50	7.5	10	-	19.6		364	338	326	300	269	233	177	118	334~148

Model		Power		Rate Current (A)		Flow										Head Range (m)	
Single-Phase	Three-Phase	kW	HP	Single-Phase	Three-Phase	m ³ /h	0	1.2	2.4	3.6	4.8	6	7.2	8.4	9.6		10.8
220V	380V			220V	380V	l/min	0	20	40	60	80	100	120	140	160		180
4SAm8/5	-	0.55	0.75	5.2	-	H(m)	32	31	28	26	25	23	21	17	13	7	28~11
4SAm8/7	4SA8/7	0.75	1	6.9	2.7		46	44	41	37	35	33	30	26	20	12	41~17
4SAm8/9	4SA8/9	1.1	1.5	9.5	3.6		57	56	52	48	45	43	39	34	26	17	52~23
4SAm8/12	4SA8/12	1.5	2	12.2	4.8		77	76	70	65	61	58	53	46	36	23	70~32
4SAm8/18	4SA8/18	2.2	3	17.3	6.4		118	114	106	98	94	88	80	70	54	35	106~48
4SAm8/24	4SA8/24	3	4	21	10.5		153	149	142	130	122	117	106	91	72	46	142~64
4SAm8/30	4SA8/30	4	5.5	27	12.7		191	187	178	163	153	147	133	114	89	54	178~78
-	4SA8/38	5.5	7.5	-	17.5		237	232	221	203	191	181	164	140	106	62	221~93
-	4SA8/46	7.5	10	-	19.6		285	277	264	244	229	217	195	163	123	69	264~106

Model		Power		Rate Current (A)		Flow								Head Range (m)	
Single-Phase	Three-Phase	kW	HP	Single-Phase	Three-Phase	m ³ /h	0	1.8	3.6	5.4	7.2	9	10.8		12.6
220V	380V			220V	380V	l/min	0	30	60	90	120	150	180		210
4SAm10/5	4SA10/5	0.75	1	6.9	2.7	H(m)	31	30	29	27	26	23	18	9	29~9
4SAm10/7	4SA10/7	1.1	1.5	9.5	3.6		43	42	40	39	36	33	27	15	40~15
4SAm10/10	4SA10/10	1.5	2	12.2	4.8		63	61	58	55	53	46	38	21	59~21
4SAm10/14	4SA10/14	2.2	3	17.3	6.4		90	89	82	77	74	64	49	26	84~26
4SAm10/18	4SA10/18	3	4	21	10.5		113	110	102	99	95	83	66	41	105~41
4SAm10/22	4SA10/22	4	5.5	27	12.7		136	133	125	121	117	105	84	50	128~50
-	4SA10/28	5.5	7.5	-	17.5		172	168	158	152	146	125	103	62	161~62
-	4SA10/34	7.5	10	-	19.6		206	202	191	184	175	155	121	72	194~72

Model		Power		Rate Current (A)		Flow											Head Range (m)
Single-Phase	Three-Phase	kW	HP	Single-Phase	Three-Phase	m ³ /h	0	1.8	3.6	5.4	7.2	9	10.8	12.6	14.4	16.2	
220V	380V			220V	380V	l/min	0	30	60	90	120	150	180	210	240	270	
4SAm12/4	4SA12/4	0.75	1	6.9	2.7	H(m)	25	24	23	22	21	19	16	13	10	3	23~9
4SAm12/6	4SA12/6	1.1	1.5	9.5	3.6		38	37	36	35	33	29	25	21	16	6	35~16
4SAm12/8	4SA12/8	1.5	2	12.2	4.8		53	52	51	47	43	40	34	30	23	9	49~21
4SAm12/12	4SA12/12	2.2	3	17.3	6.4		78	77	76	70	64	58	51	44	36	14	73~35
4SAm12/16	4SA12/16	3	4	21	10.5		103	102	98	90	83	75	66	57	45	19	95~45
4SAm12/20	4SA12/20	4	5.5	27	12.7		127	126	124	115	105	96	85	77	58	25	119~56
-	4SA12/26	5.5	7.5	-	17.5		165	164	158	147	136	123	109	93	74	33	152~69
-	4SA12/32	7.5	10	-	19.6		202	201	193	178	165	150	135	114	93	43	189~88

Model		Power		Rate Current (A)		Flow										Head Range (m)
Single-Phase	Three-Phase	kW	HP	Single-Phase	Three-Phase	m ³ /h	0	3	6	9	12	15	18	21		
220V	380V			220V	380V	l/min	0	50	100	150	200	250	300	350		
4SAm16/4	4SA16/4	1.1	1.5	9.5	3.6	H(m)	25	24	21	19	15	12	7	-	23~3	
4SAm16/6	4SA16/6	1.5	2	12.2	4.8		37	35	32	29	25	20	13	3	34~8	
4SAm16/9	4SA16/9	2.2	3	17.3	6.4		53	51	47	42	36	29	19	5	49~13	
4SAm16/12	4SA16/12	3	4	21	10.5		72	70	67	60	51	44	29	8	68~19	
4SAm16/16	4SA16/16	4	5.5	27	12.7		96	93	88	80	69	58	39	10	91~25	
-	4SA16/20	5.5	7.5	-	17.5		120	117	110	100	86	72	49	12	114~32	
-	4SA16/24	7.5	10	-	19.6		145	140	132	119	103	87	59	15	136~38	

Components & Materials

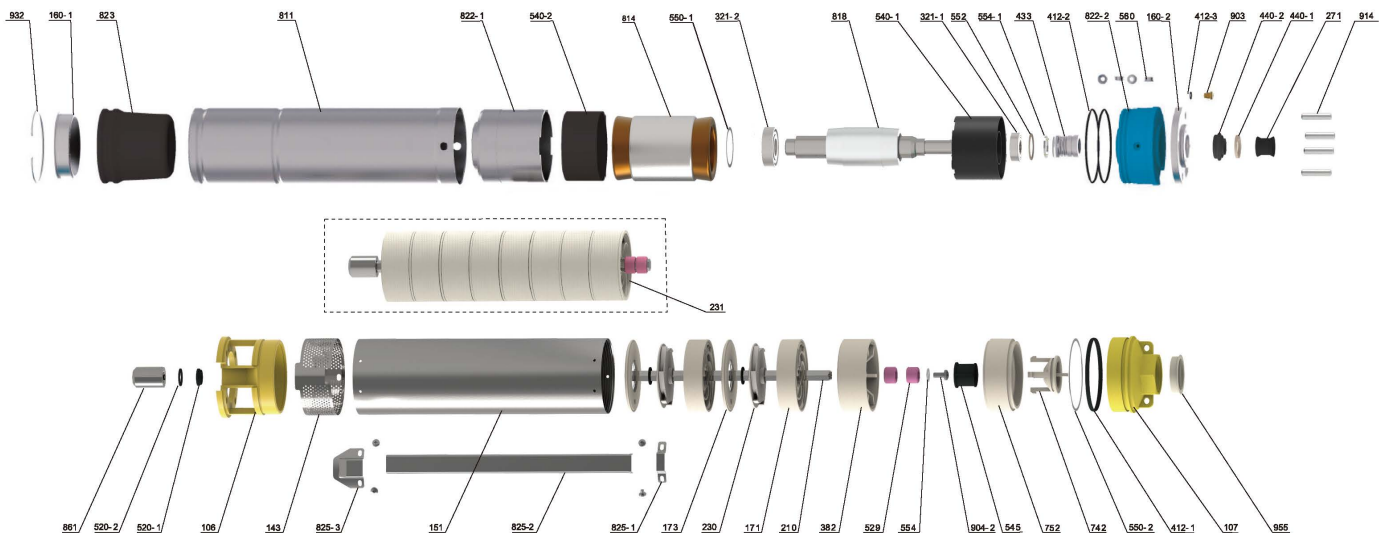

No.	Part name	No.	Part name	No.	Part name
106	Inlet joint	412-2	O-ring	742	Bonnet
107	Delivery chamber	412-3	O-ring	811	Casing
143	Net cover	433	Mechanical seal	814	Stator core with winding
151	Sleeve	440-1	Anti-sand pad	818	Rotor
160-1	Bottom cover	440-2	Anti-sand seat	822-1	Lower bearing block
160-2	Cover plate	520-1	Spacer bush	822-2	Oil chamber
171	Guide vane	520-2	Spacer bush	823	Pressure regulating film
173	Guide vane cover plate	529	Shaft sleeve	825-1	Small pressing plate
210	Pump shaft	540-1	Upper spacer sleeve	825-2	Cable pressing plate
230	Impeller	540-2	Lower spacer sleeve	861	Coupling
231	Impeller string	545	Middle rubber bearing	903	Vent cock
271	Sand shaking sleeve	550-1	Adjusting washer	914	Hexagon socket set screw
321-1	Deep groove ball bearing	550-2	Adjusting washer	932	Retaining ring
321-2	Angular contact bearing	552	Wave spring	955	Dust cover
382	Middle bearing block	554	Flat washer		
412-1	O-ring	560	Locating pin		

Dimensions & Weight

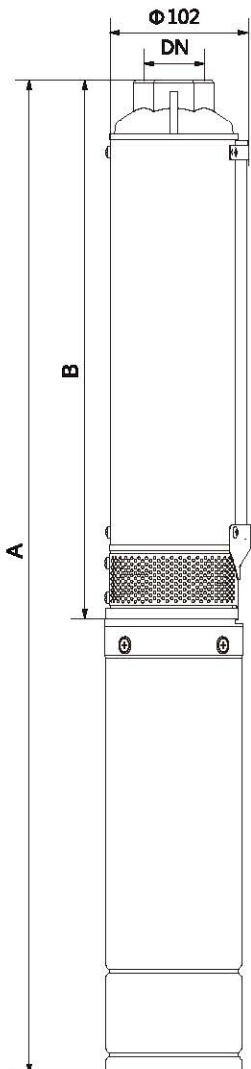

Model		Pipe Connection (DN)	Dim. (mm)			N.W.(kg)		
Single-phase	Three-phase		B	A Single-Phase	A Three-phase	Body(kg)	Motor(kg)	
						Single-phase	Three-phase	
4SAm2/8	-	G1 1/4	391	715	-	3.2	9.0	-
4SAm2/11	-		465	809	-	3.8	9.8	-
4SAm2/16	4SA2/16		590	959	1007	5.0	11.0	9.3
4SAm2/22	4SA2/22		774	1178	1226	6.2	13.0	11.4
4SAm2/28	4SA2/28		958	1407	1420	7.4	15.0	12.0
4SAm2/38	4SA2/38		1206	1715	1723	9.2	20.5	14.5
4SAm2/50	4SA2/50		1540	2234	2155	12.1	21	18.5
4SAm2/62	4SA2/62		1873	2627	2568	13.8	23.5	21.5

Model		Pipe Connection (DN)	Dim. (mm)			N.W.(kg)		
Single-phase	Three-phase		B	A Single-Phase	A Three-phase	Body(kg)	Motor(kg)	
						Single-phase	Three-phase	
4SAm3/7	-	G1 1/4	379	703	-	3.0	9.0	-
4SAm3/9	-		431	775	-	3.4	9.8	-
4SAm3/13	4SA3/13		536	905	963	4.2	11.0	9.3
4SAm3/17	4SA3/17		640	1044	1107	5.0	13.0	11.4
4SAm3/21	4SA3/21		814	1263	1301	6.0	15.0	12.0
4SAm3/30	4SA3/30		1049	1587	1585	8.0	20.5	14.5
4SAm3/40	4SA3/40		1344	2168	1959	10.4	21	18.5
4SAm3/50	4SA3/50		1605	2359	2299	12.6	23.5	21.5
-	4SA3/60		1900	-	2660	14.8	-	25.5

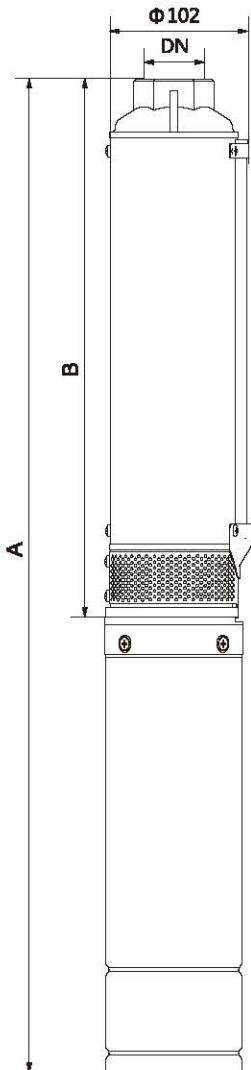

Model		Pipe Connection (DN)	Dim. (mm)			N.W.(kg)		
Single-phase	Three-phase		B	A Single-Phase	A Three-phase	Body(kg)	Motor(kg)	
							Single-phase	Three-phase
4SAm4/6	-	G1 1/4	367	691	-	3.0	9.0	-
4SAm4/7	-		396	740	-	3.2	9.8	-
4SAm4/10	4SA4/10		483	851	900	3.8	11.0	9.3
4SAm4/14	4SA4/14		599	1003	1051	4.7	13.0	11.4
4SAm4/18	4SA4/18		785	1234	1247	5.7	15.0	12.0
4SAm4/24	4SA4/24		959	1468	1476	7.1	20.5	14.5
4SAm4/32	4SA4/32		1227	1921	1842	9.2	21	18.5
4SAm4/40	4SA4/40		1459	2213	2154	11.2	23.5	21.5
-	4SA4/50		1785	-	2545	13.3	-	25.5
-	4SA4/60		2075	-	2950	14.8	-	31.5

Model		Pipe Connection (DN)	Dim. (mm)			N.W.(kg)		
Single-phase	Three-phase		B	A Single-Phase	A Three-phase	Body(kg)	Motor(kg)	
							Single-phase	Three-phase
4SAm6/5	-	G1 1/2	352	676	-	2.7	9.0	-
4SAm6/6	-		384	728	-	3.0	9.8	-
4SAm6/8	4SA6/8		450	819	867	3.5	11.0	9.3
4SAm6/11	4SA6/11		549	953	1001	4.1	13.0	11.4
4SAm6/14	4SA6/14		683	1132	1145	5.0	15.0	12.0
4SAm6/20	4SA6/20		914	1423	1431	6.6	20.5	14.5
4SAm6/26	4SA6/26		1111	1805	1726	7.9	21	18.5
4SAm6/34	4SA6/34		1407	2161	2102	10.1	23.5	21.5
-	4SA6/42		1670	-	2430	12.0	-	25.5
-	4SA6/50		1969	-	2844	14.0	-	31.5

Model		Pipe Connection (DN)	Dim. (mm)			N.W.(kg)		
Single-phase	Three-phase		B	A Single-Phase	A Three-phase	Body(kg)	Motor(kg)	
							Single-phase	Three-phase
4SAm8/5	-	G2 2	387	731	-	3.1	9.0	-
4SAm8/7	4SA8/7		463	832	890	3.7	11.0	9.3
4SAm8/9	4SA8/9		539	943	1006	4.2	13.0	11.4
4SAm8/12	4SA8/12		689	1138	1176	5.0	15.0	12.0
4SAm8/18	4SA8/18		952	1491	1489	7.0	20.5	14.5
4SAm8/24	4SA8/24		1180	1874	1795	8.7	21	18.5
4SAm8/30	4SA8/30		1444	2198	2138	10.5	23.5	21.5
-	4SA8/38		1783	-	2543	12.9	-	25.5
-	4SA8/46		2087	-	2962	15.3	-	31.5

Model		Pipe Connection (DN)	Dim. (mm)			N.W.(kg)		
Single-phase	Three-phase		B	A Single-Phase	A Three-phase	Body(kg)	Motor(kg)	
							Single-phase	Three-phase
4SAm10/5	4SA10/5	G2 2	387	756	814	3.1	11.0	9.3
4SAm10/7	4SA10/7		463	867	930	3.6	13.0	11.4
4SAm10/10	4SA10/10		613	1061	1099	4.5	15.0	12
4SAm10/14	4SA10/14		800	1339	1337	5.8	20.5	14.5
4SAm10/18	4SA10/18		952	1646	1567	6.8	21	18.5
4SAm10/22	4SA10/22		1104	1858	1799	8.0	23.5	21.5
-	4SA10/28		1367	-	2127	9.3	-	25.5
-	4SA10/34		1596	-	2471	10.7	-	31.5

Model		Pipe Connection (DN)	Dim. (mm)			N.W.(kg)		
Single-phase	Three-phase		B	A Single-Phase	A Three-phase	Body(kg)	Motor(kg)	
							Single-phase	Three-phase
4SAm12/4	4SA12/4	G2 2	438	807	855	3.6	11.0	9.3
4SAm12/6	4SA12/6		536	940	988	4.4	13.0	11.4
4SAm12/8	4SA12/8		633	1082	1095	5.2	15.0	12.0
4SAm12/12	4SA12/12		884	1393	1401	7.1	20.5	14.5
4SAm12/16	4SA12/16		1078	1772	1693	8.7	21	18.5
4SAm12/20	4SA12/20		1329	2083	2024	10.6	23.5	21.5
-	4SA12/26		1621	-	2381	13.7	-	25.5
-	4SA12/32		1969	-	2844	16.4	-	31.5

Model		Pipe Connection (DN)	Dim. (mm)			N.W.(kg)		
Single-phase	Three-phase		B	A Single-Phase	A Three-phase	Body(kg)	Motor(kg)	
							Single-phase	Three-phase
4SAm16/4	4SA16/4	G2 2	550	955	1018	4.1	13.0	11.4
4SAm16/6	4SA16/6		702	1151	1189	5.3	15.0	12
4SAm16/9	4SA16/9		929	1469	1467	6.8	20.5	14.5
4SAm16/12	4SA16/12		1157	1851	1772	8.3	21	18.5
4SAm16/16	4SA16/16		1460	2214	2155	10.4	23.5	21.5
-	4SA16/20		1763	-	2523	12.5	-	25.5
-	4SA16/24		2066	-	2942	14.5	-	31.5

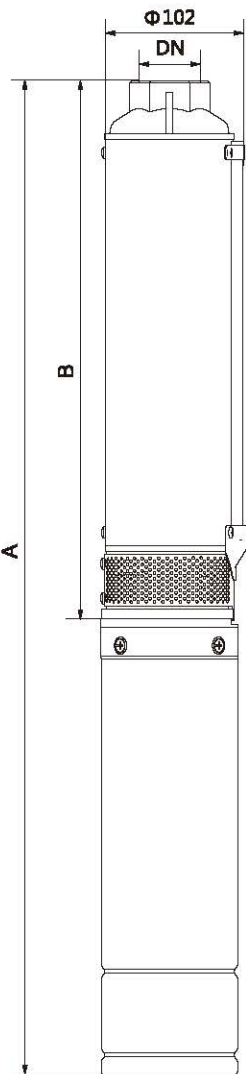

Packing Size & Weight

Model		Dim. (mm)					G.W.(kg)		20"Loading Qty.(pcs)	
Single-phase	Three-phase	Motor(L×W×H)		Body (L×W×H)	Pump(L×W×H)		Single-phase	Three-phase	Single-phase	Three-phase
		Single-phase	Three-phase		Single-phase	Three-phase				
4SAm2/8	-	-	-	-	1020×110×185	-	13.7	-	1300	-
4SAm2/11	-	-	-	-	1100×110×185	-	15.1	-	1170	-
4SAm2/16	4SA2/16	-	-	-	1280×110×185	1130×110×185	17.5	15.8	1030	1230
4SAm2/22	4SA2/22	-	-	-	1500×110×185	1310×110×185	20.7	19.1	870	1000
4SAm2/28	4SA2/28	770×125×225	645×125×125	1075×125×125	-	-	M:17 B:8.4	M:14B:8.4	680	1030
4SAm2/38	4SA2/38	870×125×225	690×125×125	1310×125×125	-	-	M:22.5 B:10.2	M:16.5 B:10.2	560	840
4SAm2/50	4SA2/50	825×125×125	780×125×125	1680×125×125	-	-	M:22.5 B:14.1	M:20.5 B:14.1	650	700
4SAm2/62	4SA2/62	920×125×125	825×125×125	1980×125×125	-	-	M:25 B:16	M:23.5 B:16	550	590

Model		Dim. (mm)					G.W.(kg)		20"Loading Qty.(pcs)	
Single-phase	Three-phase	Motor(L×W×H)		Body (L×W×H)	Pump(L×W×H)		Single-phase	Three-phase	Single-phase	Three-phase
		Single-phase	Three-phase		Single-phase	Three-phase				
4SAm3/7	-	-	-	-	1020×110×185	-	13.5	-	1300	-
4SAm3/9	-	-	-	-	1075×110×185	-	14.7	-	1230	-
4SAm3/13	4SA3/13	-	-	-	1220×110×185	1075×110×185	16.7	15.0	1080	1300
4SAm3/17	4SA3/17	-	-	-	1360×110×185	1220×110×185	19.5	17.9	960	1150
4SAm3/21	4SA3/21	770×125×225	645×125×125	935×125×125	-	-	M:17 B:7.5	M:14B:7.5	720	1130
4SAm3/30	4SA3/30	880×125×225	690×125×125	1180×125×125	-	-	M:22.5 B:9.5	M:16.5 B:9.5	600	930
4SAm3/40	4SA3/40	825×125×125	780×125×125	1460×125×125	-	-	M:22.5 B:11.9	M:20.5 B:11.9	750	780
4SAm3/50	4SA3/50	920×125×125	825×125×125	1735×125×125	-	-	M:25 B:14.6	M:23.5 B:14.6	600	660
-	4SA3/60	-	920×125×125	2015×125×125	-	-	-	M:27.5 B:16.8	-	570

Model		Dim. (mm)					G.W.(kg)		20"Loading Qty.(pcs)	
Single-phase	Three-phase	Motor(L×W×H)		Body (L×W×H)	Pump(L×W×H)		Single-phase	Three-phase	Single-phase	Three-phase
		Single-phase	Three-phase		Single-phase	Three-phase				
4SAm4/6	-	-	-	-	1020×110×185	-	13.5	-	1300	-
4SAm4/7	-	-	-	-	1075×110×185	-	14.5	-	1230	-
4SAm4/10	4SA4/10	-	-	-	1150×110×185	980×110×185	16.3	14.6	1120	1350
4SAm4/14	4SA4/14	-	-	-	1310×110×185	1130×110×185	19.2	17.6	1000	1170
4SAm4/18	4SA4/18	770×125×225	645×125×125	890×125×125	-	-	M:17 B:7.2	M:14B:7.2	740	1160
4SAm4/24	4SA4/24	880×125×225	690×125×125	1075×125×125	-	-	M:22.5 B:8.6	M:16.5 B:8.6	630	990
4SAm4/32	4SA4/32	825×125×125	780×125×125	1360×125×125	-	-	M:22.5 B:10.7	M:20.5 B:10.7	780	820
4SAm4/40	4SA4/40	920×125×125	825×125×125	1550×125×125	-	-	M:25 B:13.2	M:23.5 B:13.2	680	720
-	4SA4/50	-	920×125×125	1910×125×125	-	-	-	M:27.5 B:15.3	-	600
-	4SA4/60	-	1040×125×125	2200×125×125	-	-	-	M:33.5 B:16.8	-	510

Model		Dim. (mm)					G.W.(kg)		20"Loading Qty.(pcs)	
Single-phase	Three-phase	Motor(L×W×H)		Body (L×W×H)	Pump(L×W×H)		Single-phase	Three-phase	Single-phase	Three-phase
		Single-phase	Three-phase		Single-phase	Three-phase				
4SAm6/5	-	-	-	-	980×110×185	-	13.2	-	1350	-
4SAm6/6	-	-	-	-	1020×110×185	-	14.3	-	1300	-
4SAm6/8	4SA6/8	-	-	-	1130×110×185	955×110×185	16.0	14.3	1170	1420
4SAm6/11	4SA6/11	-	-	-	1280×110×185	1100×110×185	18.6	17	1050	1230
4SAm6/14	4SA6/14	770×125×225	645×125×125	770×125×125	-	-	M:17 B:6	M:14 B:6	780	1270
4SAm6/20	4SA6/20	880×125×225	690×125×125	1020×125×125	-	-	M:22.5 B:8.1	M:16.5 B:8.1	650	1050
4SAm6/26	4SA6/26	825×125×125	780×125×125	1210×125×125	-	-	M:22.5 B:9.4	M:20.5 B:9.4	850	900
4SAm6/34	4SA6/34	920×125×125	825×125×125	1500×125×125	-	-	M:25 B:12.1	M:23.5 B:12.1	700	750
-	4SA6/42	-	920×125×125	1800×125×125	-	-	-	M:27.5 B:14	-	650
-	4SA6/50	-	1040×125×125	2060×125×125	-	-	-	M:33.5 B:16	-	560

Model		Dim. (mm)					G.W.(kg)		20"Loading Qty.(pcs)	
Single-phase	Three-phase	Motor(L×W×H)		Body (L×W×H)	Pump(L×W×H)		Single-phase	Three-phase	Single-phase	Three-phase
		Single-phase	Three-phase		Single-phase	Three-phase				
4SAm8/5	-	-	-	-	1020×110×185	-	14.4	-	1300	-
4SAm8/7	4SA8/7	-	-	-	1130×110×185	980×110×185	16.2	14.5	1170	1420
4SAm8/9	4SA8/9	-	-	-	1255×110×185	1130×110×185	18.7	17	1050	1230
4SAm8/12	4SA8/12	770×125×225	645×125×125	810×125×125	-	-	M:17 B:6	M:14 B:6	770	1230
4SAm8/18	4SA8/18	880×125×225	690×125×125	1075×125×125	-	-	M:22.5 B:8	M:16.5 B:8	630	1000
4SAm8/24	4SA8/24	825×125×125	780×125×125	1310×125×125	-	-	M:22.5 B:10.2	M:20.5 B:10.2	800	840
4SAm8/30	4SA8/30	920×125×125	825×125×125	1550×125×125	-	-	M:25 B:12.1	M:23.5 B:12	680	720
-	4SA8/38	-	920×125×125	1910×125×125	-	-	-	M:27.5 B:14.9	-	600
-	4SA8/46	-	1040×125×125	2200×125×125	-	-	-	M:33.5 B:17.3	-	510

Model		Dim. (mm)					G.W.(kg)		20"Loading Qty.(pcs)	
Single-phase	Three-phase	Motor(L×W×H)		Body (L×W×H)	Pump(L×W×H)		Single-phase	Three-phase	Single-phase	Three-phase
		Single-phase	Three-phase		Single-phase	Three-phase				
4SAm10/5	4SA10/5	-	-	-	1075×110×185	955×110×185	15.6	13.9	1230	1500
4SAm10/7	4SA10/7	-	-	-	1180×110×185	1020×110×185	18.1	16.5	1120	1350
4SAm10/10	4SA10/10	770×125×225	645×125×125	730×125×125	-	-	M:17 B:5.5	M:14 B:5.5	800	1310
4SAm10/14	4SA10/14	880×125×225	690×125×125	890×125×125	-	-	M:22.5 B:6.7	M:16.5 B:6.7	680	1120
4SAm10/18	4SA10/18	825×125×125	780×125×125	1075×125×125	-	-	M:22.5 B:8.3	M:20.5 B:8.3	900	960
4SAm10/22	4SA10/22	920×125×125	825×125×125	1210×125×125	-	-	M:25 B:9.5	M:23.5 B:9.5	800	850
-	4SA10/28	-	920×125×125	1460×125×125	-	-	-	M:27.5 B:10.8	-	720
-	4SA10/34	-	1040×125×125	1680×125×125	-	-	-	M:33.5 B:12.7	-	630

Model		Dim. (mm)					G.W.(kg)		20"Loading Qty.(pcs)	
Single-phase	Three-phase	Motor(LxWxH)		Body (LxWxH)	Pump(LxWxH)		Single-phase	Three-phase	Single-phase	Three-phase
		Single-phase	Three-phase		Single-phase	Three-phase				
4SA12/4	4SA12/4	-	-	-	1100x110x185	935x110x185	16.1	14.4	1170	1420
4SA12/6	4SA12/6	-	-	-	1255x110x185	1075x110x185	18.9	17.3	1050	1230
4SA12/8	4SA12/8	770x125x225	645x125x125	730x125x125	-	-	M:17 B:6.2	M:14B:6.2	1150	1310
4SA12/12	4SA12/12	880x125x225	690x125x225	1020x125x125	-	-	M:22.5 B:8.1	M:16.5 B:8.1	900	1030
4SA12/16	4SA12/16	825x125x125	780x125x225	1180x125x125	-	-	M:22.5 B:10.2	M:20.5 B:10.2	850	900
4SA12/20	4SA12/20	920x125x125	825x125x225	1460x125x125	-	-	M:25 B:12.1	M:23.5 B:12.1	700	750
-	4SA12/26	-	920x125x225	1735x125x125	-	-	-	M:27.5 B:15.7	-	640
-	4SA12/32	-	1040x125x125	2060x125x125	-	-	-	M:33.5 B:18.4	-	540

Model		Dim. (mm)					G.W.(kg)		20"Loading Qty.(pcs)	
Single-phase	Three-phase	Motor(LxWxH)		Body (LxWxH)	Pump(LxWxH)		Single-phase	Three-phase	Single-phase	Three-phase
		Single-phase	Three-phase		Single-phase	Three-phase				
4SA16/4	4SA16/4	-	-	-	1255x110x185	1075x110x185	18.6	17	1050	1230
4SA16/6	4SA16/6	770x125x225	590x125x125	810x125x125	-	-	M:17 B:5.1	M:17.7 B:6.3	1080	1230
4SA16/9	4SA16/9	880x125x225	645x125x125	1020x125x125	-	-	M:27.7 B:6.8	M:21.7 B:7.8	900	1030
4SA16/12	4SA16/12	825x125x125	700x125x125	1255x125x125	-	-	M:22.5 B:9.8	M:27.2 B:9.8	820	870
4SA16/16	4SA16/16	920x125x125	780x125x125	1550x125x125	-	-	M:25 B:11.9	M:31.7 B:11.9	680	720
-	4SA16/20	-	870x125x125	1855x125x125	-	-	-	M:37.8 B:14.5	-	610
-	4SA16/24	-	975x125x125	2150x125x125	-	-	-	M:46.8 B:16.5	-	520

NOTE: Motor packaged without submersible drop cable, package dimensions enlarged if necessary.

